

# POOLSPA

PRICE LIST 2026  
PREPLUMBED SPA BATHTUBS



SPA MILA

spa shell  
**POOLSPA**

**PL**  
**POLISH  
PRODUCER**

  
**HIGH QUALITY  
COMPONENTS**

**25**  
YEARS EXPERIENCE  
IN BATHTUB  
MANUFACTURE

[www.poolspa.pl](http://www.poolspa.pl)



SPA VICTORIA

**POOLSPA**

PRICE LIST 2026

### STATIONARY SPA BATHTUBS

MILA 250 x 250 with gutter.....	4
MILA 250 x 250 with gutter, 32 jets .....	5
OLIMPIA 250 x 250 with gutter .....	6
OLIMPIA 250 x 250 with gutter, 32 jets.....	7
JANETTE 175 x 193 with skimmer .....	8
JANETTE 197 x 215 with gutter .....	8
JANETTE 197 x 215 with gutter, 32 jets .....	9
OCTAVIA 179 x 179 with skimmer .....	10
OCTAVIA 226 x 226 with gutter .....	10
OCTAVIA 226 x 226 with gutter, 32 jets .....	11
VICTORIA Ø 177 with skimmer .....	12
VICTORIA Ø 249 with gutter .....	12
VICTORIA Ø 249 with gutter, 32 jets .....	13
CLASSIC 186 x 213 with skimmer .....	14
CLASSIC 260 x 234 with gutter .....	14
CLASSIC 260 x 234 with gutter, 32 jets.....	15
NATALIE 253 x 253 with gutter.....	16
NATALIE 253 x 253 with gutter, 32 jets .....	17
SUNFLOWER Ø 283 with gutter.....	18
SUNFLOWER Ø 283 with gutter, 32 jets.....	19
VESTA 230 x 230 with skimmer.....	20
VESTA 290 x 290 with gutter.....	20
VESTA 290 x 290 with gutter, 32 jets .....	21
OLIVIA 248 x 299 with gutter .....	22
OLIVIA 248 x 299 with gutter, 32 jets .....	23
<b>Plumbing schemes .....</b>	<b>24</b>
<b>Jet layouts.....</b>	<b>26</b>
<b>Warranty.....</b>	<b>27</b>



PRODUCT / EQUIPMENT	CATALOGUE NO.	NET PRICE EUR
<b>32 jets</b> SPA preplumbed with air channels + white LED light	PWW7A10U32B0209	15 440
SPA preplumbed with air channels + 24 multicolor LED lights	PWW7A10U32B1885	16 650
Full foaming		690
Brown thermal cover	PI9000308	3 030

### MILA 250 × 250

with gutter, 32 jets

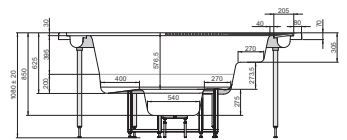
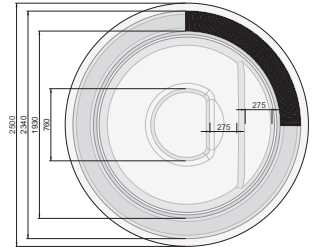

### GENERAL INFORMATION

length:	250 cm	number of jets:	32
width:	250 cm	number of air holes:	89
height:	108 ±2 cm	number of suctions:	4
number of seats:	5	number of hidden air inlets:	4
capacity:	1380 l	number of massage points:	121

Jets layout A

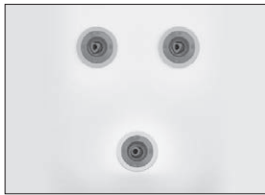

Jets layout B

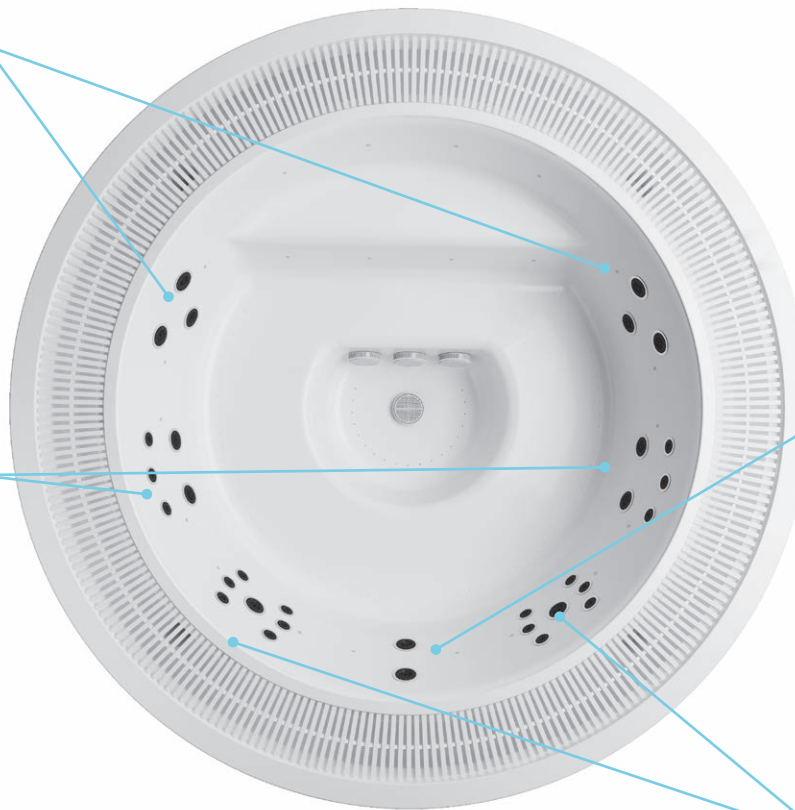

Jets layout F



Jets layout D



# STATIONARY SPA BATHTUBS

MULTI-USER, PREPLUMBED VERSIONS

## OLIMPIA 250 × 250

with gutter

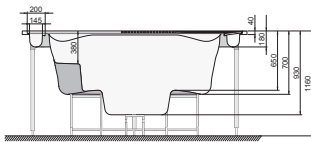
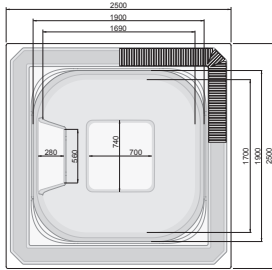

	PRODUCT / EQUIPMENT	CATALOGUE NO.	NET PRICE EUR
7 jets	SPA preplumbed with air channels	PWW7110U00B0000	12 600
	SPA preplumbed with air channels + white LED light	PWW7110U00B0209	13 130
	SPA preplumbed with air channels + 24 multicolor LED lights	PWW7110U00B1885	14 340
14 jets	SPA preplumbed with air channels	PWW7110U02B0000	14 100
	SPA preplumbed with air channels + white LED light	PWW7110U02B0209	14 630
	SPA preplumbed with air channels + 24 multicolor LED lights	PWW7110U02B1885	15 840
	Full foaming		690
	Brown thermal cover	PI9000580	3 150

### GENERAL INFORMATION

length:	250 cm	number of jets:	7-14
width:	250 cm	number of air holes:	106
height:	116 ± 2 cm	number of suction:	3-4
number of seats:	7	number of hidden air inlets:	2-4
capacity:	2000 l	number of massage points:	113-120



# STATIONARY SPA BATHTUBS

MULTI-USER, PREPLUMBED VERSIONS

# POOLSPA

## JANETTE 175 × 193

with skimmer

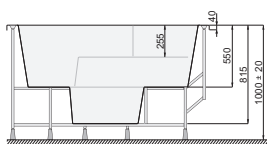
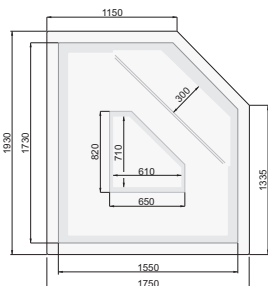

	PRODUCT / EQUIPMENT	CATALOGUE NO.	NET PRICE EUR
6 jets	SPA preplumbed with air channels	PWW8510U00B0000	8 000
	SPA preplumbed with air channels + white LED light	PWW8510U00B0209	8 530
	SPA preplumbed with air channels + 24 multicolor LED lights	PWW8510U00B1885	9 740
12 jets	SPA preplumbed with air channels	PWW8510U02B0000	9 300
	SPA preplumbed with air channels + white LED light	PWW8510U02B0209	9 830
	SPA preplumbed with air channels + 24 multicolor LED lights	PWW8510U02B1885	11 040
	Full foaming		690
	Brown thermal cover	PI9000315	2 180

### GENERAL INFORMATION

length:	175 cm	number of jets:	6-12
width:	193 cm	number of air holes:	104
height:	100 ± 2 cm	number of suctions:	2-3
number of seats:	3	number of air regulators:	2-4
capacity:	700 l	number of massage points:	110-116

## JANETTE 197 × 215

with gutter

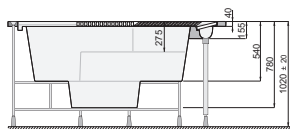
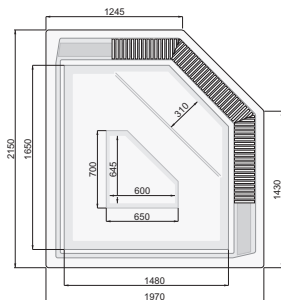

	PRODUCT / EQUIPMENT	CATALOGUE NO.	NET PRICE EUR
6 jets	SPA preplumbed with air channels	PWW8410U00B0000	10 400
	SPA preplumbed with air channels + white LED light	PWW8410U00B0209	10 930
	SPA preplumbed with air channels + 24 multicolor LED lights	PWW8410U00B1885	12 140
12 jets	SPA preplumbed with air channels	PWW8410U02B0000	11 700
	SPA preplumbed with air channels + white LED light	PWW8410U02B0209	12 230
	SPA preplumbed with air channels + 24 multicolor LED lights	PWW8410U02B1885	13 440
	Full foaming		690
	Brown thermal cover	PI9000316	2 670

### GENERAL INFORMATION

length:	197 cm	number of jets:	6-12
width:	215 cm	number of air holes:	104
height:	102 ± 2 cm	number of suctions:	3-4
number of seats:	4	number of hidden air inlets:	2-4
capacity:	900 l	number of massage points:	110-116

	PRODUCT / EQUIPMENT	CATALOGUE NO.	NET PRICE EUR
<b>32 jets</b>	SPA preplumbed with air channels + white LED light	PWW8410U32B0209	14 300
	SPA preplumbed with air channels + 24 multicolor LED lights	PWW8410U32B1885	15 510
	Full foaming		690
	Brown thermal cover	PI9000316	2 670

### JANETTE 197 × 215

with gutter, 32 jets

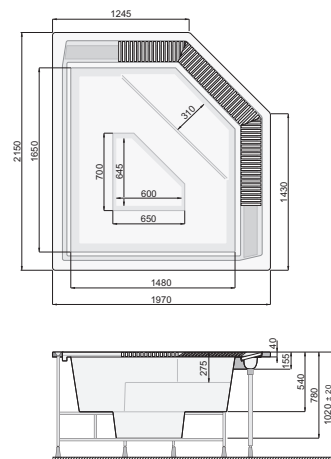

### GENERAL INFORMATION

length:	197 cm	number of jets:	32
width:	215 cm	number of air holes:	104
height:	102 ± 2 cm	number of suctions:	4
number of seats:	4	number of hidden air inlets:	4
capacity:	900 l	number of massage points:	136

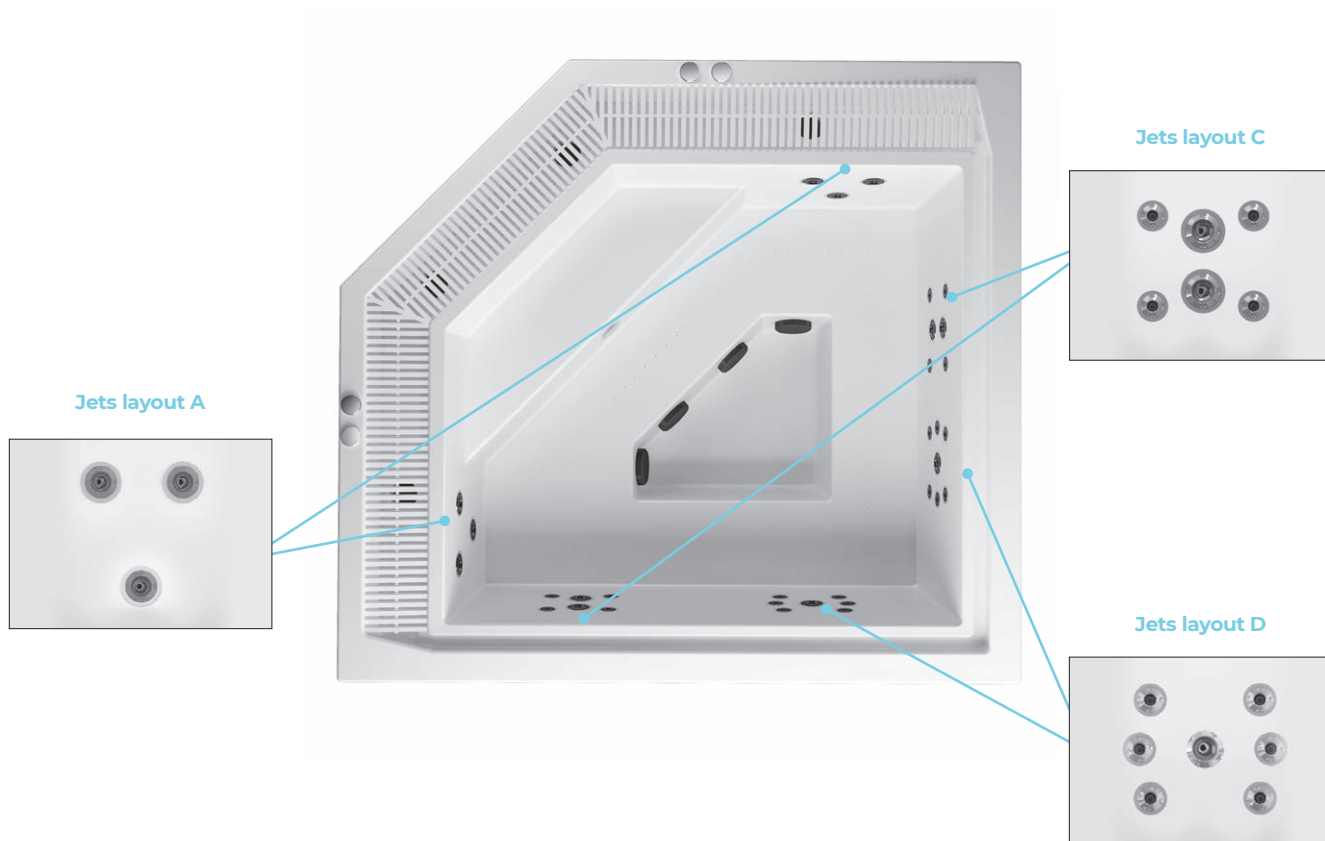

# STATIONARY SPA BATHTUBS

MULTI-USER, PREPLUMBED VERSIONS

# POOLSPA

## OCTAVIA 179 × 179

with skimmer

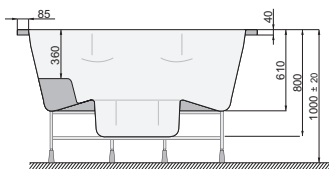
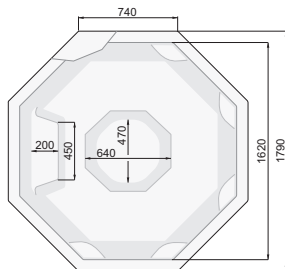

	PRODUCT / EQUIPMENT	CATALOGUE NO.	NET PRICE EUR
7 jets	SPA preplumbed with air channels	PWW8310U00B0000	8 000
	SPA preplumbed with air channels + white LED light	PWW8310U00B0209	8 530
	SPA preplumbed with air channels + 24 multicolor LED lights	PWW8310U00B1885	9 740
14 jets	SPA preplumbed with air channels	PWW8310U02B0000	9 600
	SPA preplumbed with air channels + white LED light	PWW8310U02B0209	10 130
	SPA preplumbed with air channels + 24 multicolor LED lights	PWW8310U02B1885	11 340
	Full foaming		690
	Brown thermal cover	PI9000317	2 180

### GENERAL INFORMATION

length:	179 cm	number of jets:	7-14
width:	179 cm	number of air holes:	93
height:	100 ± 2 cm	number of suctions:	2-3
number of seats:	4	number of air regulators:	2-4
capacity:	850 l	number of massage points:	100-107

## OCTAVIA 226 × 226

with gutter

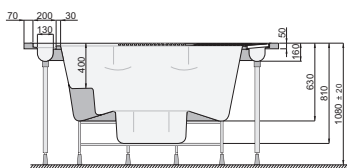
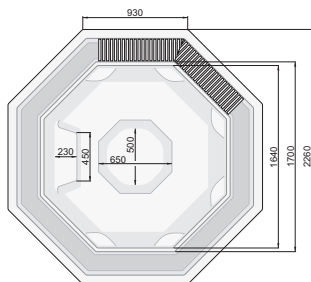

	PRODUCT / EQUIPMENT	CATALOGUE NO.	NET PRICE EUR
7 jets	SPA preplumbed with air channels	PWW8210U00B0000	10 900
	SPA preplumbed with air channels + white LED light	PWW8210U00B0209	11 430
	SPA preplumbed with air channels + 24 multicolor LED lights	PWW8210U00B1885	12 640
14 jets	SPA preplumbed with air channels	PWW8210U02B0000	12 500
	SPA preplumbed with air channels + white LED light	PWW8210U02B0209	13 030
	SPA preplumbed with air channels + 24 multicolor LED lights	PWW8210U02B1885	14 240
	Full foaming		690
	Brown thermal cover	PI9000318	2 670

### GENERAL INFORMATION

length:	226 cm	number of jets:	7-14
width:	226 cm	number of air holes:	93
height:	108 ± 2 cm	number of suctions:	3-4
number of seats:	5	number of hidden air inlets:	2-4
capacity:	1050 l	number of massage points:	100-107

PRODUCT / EQUIPMENT	CATALOGUE NO.	NET PRICE EUR
<b>32 jets</b> SPA preplumbed with air channels + white LED light	PWW8210U32B0209	14 600
SPA preplumbed with air channels + 24 multicolor LED lights	PWW8210U32B1885	15 810
Full foaming		690
Brown thermal cover	PI9000318	2 670

### OCTAVIA 226 × 226

with gutter, 32 jets

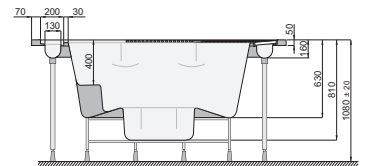
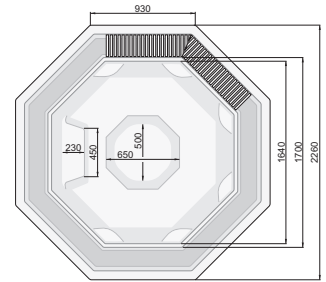

#### GENERAL INFORMATION

length:	226 cm	number of jets:	32
width:	226 cm	number of air holes:	93
height:	108 ± 2 cm	number of suctions:	4
number of seats:	5	number of hidden air inlets:	4
capacity:	1050 l	number of massage points:	125

Jets layout A



Jets layout B

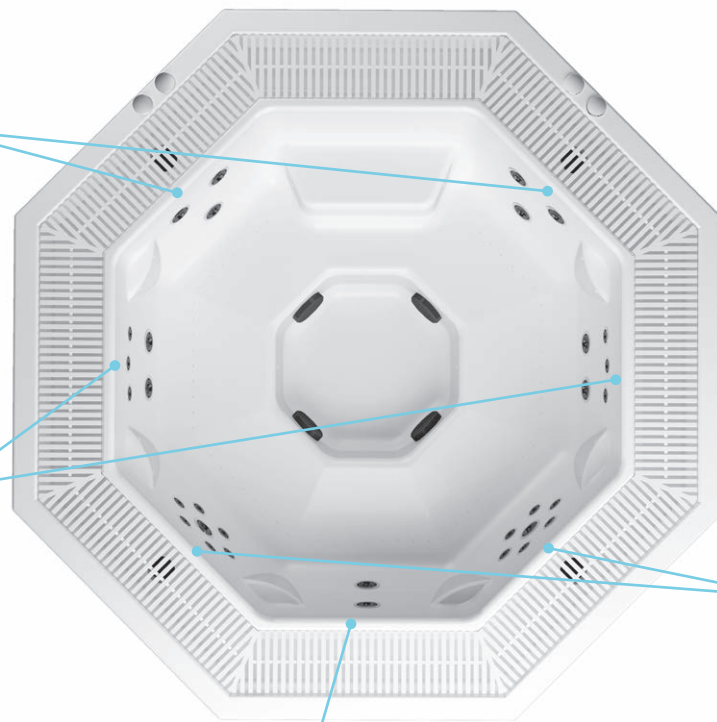
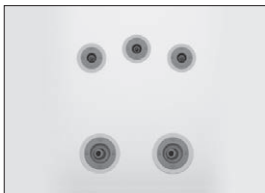

Jets layout E



Jets layout F



# STATIONARY SPA BATHTUBS

MULTI-USER, PREPLUMBED VERSIONS

# POOLSPA

## VICTORIA Ø 177

with skimmer

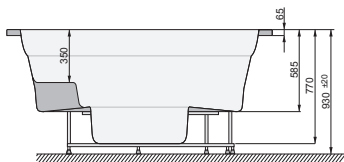
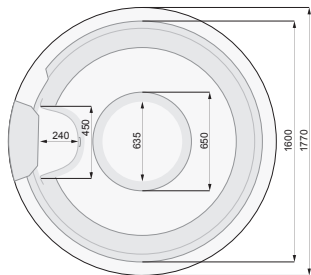

	PRODUCT / EQUIPMENT	CATALOGUE NO.	NET PRICE EUR
6 jets	SPA preplumbed with air channels	PWW8710U00B0000	7 800
	SPA preplumbed with air channels + white LED light	PWW8710U00B0209	8 330
	SPA preplumbed with air channels + 24 multicolor LED lights	PWW8710U00B1885	9 540
12 jets	SPA preplumbed with air channels	PWW8710U02B0000	9 100
	SPA preplumbed with air channels + white LED light	PWW8710U02B0209	9 630
	SPA preplumbed with air channels + 24 multicolor LED lights	PWW8710U02B1885	10 840
	Full foaming		690
	Brown thermal cover	PI9000264	2 180

### GENERAL INFORMATION

length:	177 cm	number of jets:	6-12
width:	177 cm	number of air holes:	94
height:	93 ± 2 cm	number of suction:	2-3
number of seats:	4	number of air regulators:	2-4
capacity:	800 l	number of massage points:	100-106

## VICTORIA Ø 249

with gutter

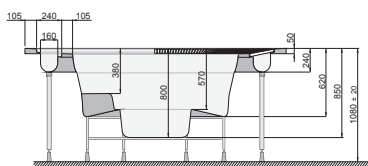
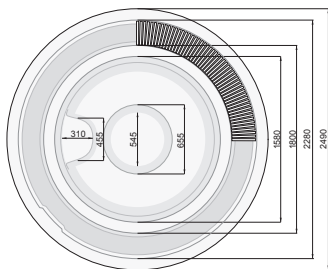

	PRODUCT / EQUIPMENT	CATALOGUE NO.	NET PRICE EUR
6 jets	SPA preplumbed with air channels	PWW8610U00B0000	10 600
	SPA preplumbed with air channels + white LED light	PWW8610U00B0209	11 130
	SPA preplumbed with air channels + 24 multicolor LED lights	PWW8610U00B1885	12 340
12 jets	SPA preplumbed with air channels	PWW8610U02B0000	11 900
	SPA preplumbed with air channels + white LED light	PWW8610U02B0209	12 430
	SPA preplumbed with air channels + 24 multicolor LED lights	PWW8610U02B1885	13 640
	Full foaming		690
	Brown thermal cover	PI9000308	3 030

### GENERAL INFORMATION

length:	249 cm	number of jets:	6-12
width:	249 cm	number of air holes:	94
height:	108 ± 2 cm	number of suction:	3-4
number of seats:	5	number of hidden air inlets:	2-4
capacity:	1100 l	number of massage points:	100-106

	PRODUCT / EQUIPMENT	CATALOGUE NO.	NET PRICE EUR
<b>32 jets</b>	SPA preplumbed with air channels + white LED light	PWW8610U32B0209	14 300
	SPA preplumbed with air channels + 24 multicolor LED lights	PWW8610U32B1885	15 510
	Full foaming		690
	Brown thermal cover	PI9000308	3 030

### VICTORIA Ø 249

with gutter, 32 jets

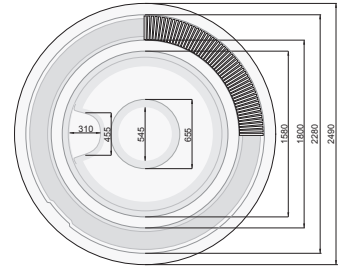

#### GENERAL INFORMATION

length:	249 cm	number of jets:	32
width:	249 cm	number of air holes:	94
height:	108 ± 2 cm	number of suctions:	4
number of seats:	5	number of hidden air inlets:	4
capacity:	1100 l	number of massage points:	126

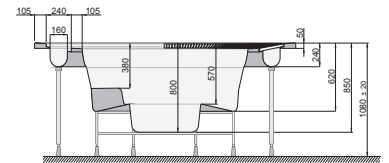

Jets layout A

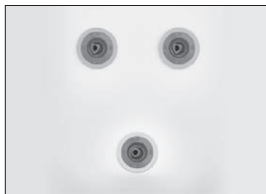

Jets layout C



Jets layout E

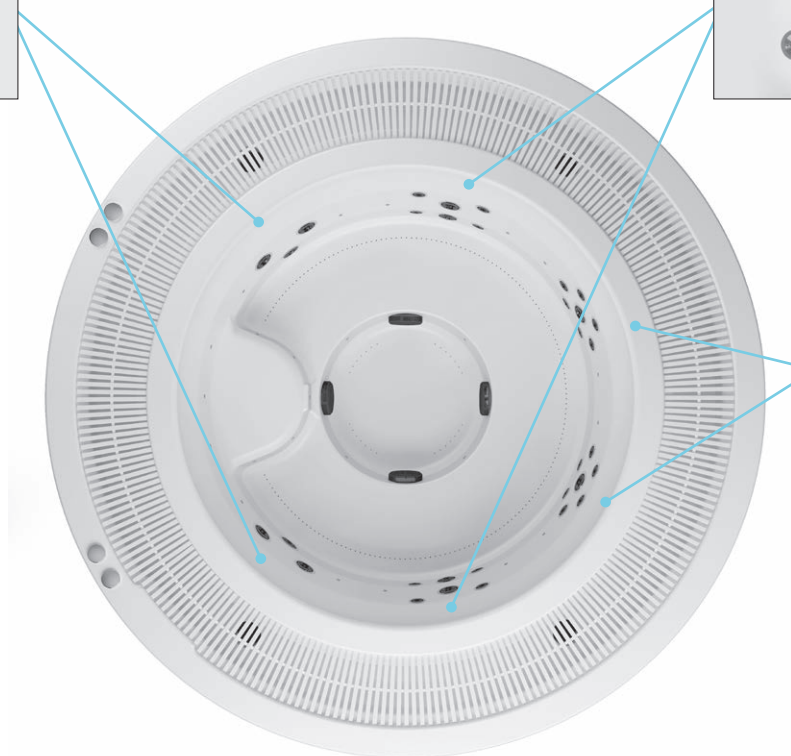
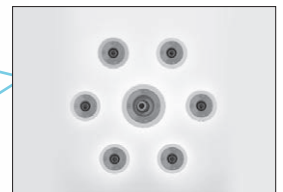

# STATIONARY SPA BATHTUBS

MULTI-USER, PREPLUMBED VERSIONS

## CLASSIC 186 × 213

with skimmer

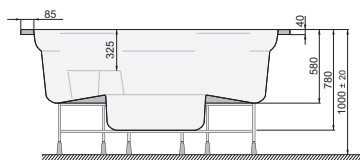
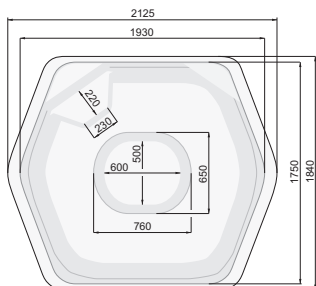

	PRODUCT / EQUIPMENT	CATALOGUE NO.	NET PRICE EUR
6 jets	SPA preplumbed with air channels	PWW8110U00B0000	7 600
	SPA preplumbed with air channels + white LED light	PWW8110U00B0209	8 130
	SPA preplumbed with air channels + 24 multicolor LED lights	PWW8110U00B1885	9 340
12 jets	SPA preplumbed with air channels	PWW8110U02B0000	8 900
	SPA preplumbed with air channels + white LED light	PWW8110U02B0209	9 430
	SPA preplumbed with air channels + 24 multicolor LED lights	PWW8110U02B1885	10 640
	Full foaming		690
	Brown thermal cover	PI9000319	2 420

### GENERAL INFORMATION

length:	186 cm	number of jets:	6-12
width:	213 cm	number of air holes:	106
height:	100 ± 2 cm	number of suction:	2-3
number of seats:	4	number of air regulators:	2-4
capacity:	1100 l	number of massage points:	112-118

## CLASSIC 260 × 234

with gutter

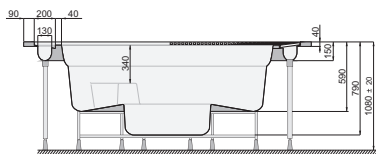
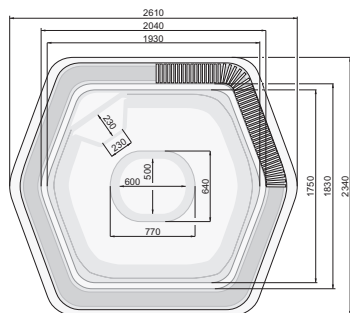

	PRODUCT / EQUIPMENT	CATALOGUE NO.	NET PRICE EUR
6 jets	SPA preplumbed with air channels	PWW8010U00B0000	10 300
	SPA preplumbed with air channels + white LED light	PWW8010U00B0209	10 830
	SPA preplumbed with air channels + 24 multicolor LED lights	PWW8010U00B1885	12 040
12 jets	SPA preplumbed with air channels	PWW8010U02B0000	11 600
	SPA preplumbed with air channels + white LED light	PWW8010U02B0209	12 130
	SPA preplumbed with air channels + 24 multicolor LED lights	PWW8010U02B1885	13 340
	Full foaming		690
	Brown thermal cover	PI9000320	2 790

### GENERAL INFORMATION

length:	260 cm	number of jets:	6-12
width:	234 cm	number of air holes:	106
height:	108 ± 2 cm	number of suction:	3-4
number of seats:	5	number of hidden air inlets:	2-4
capacity:	1400 l	number of massage points:	112-118

	PRODUCT / EQUIPMENT	CATALOGUE NO.	NET PRICE EUR
32 jets	SPA preplumbed with air channels + white LED light	PWW8010U32B0209	14 300
	SPA preplumbed with air channels + 24 multicolor LED lights	PWW8010U32B1885	15 510
	Full foaming		690
	Brown thermal cover	PI9000320	2 790

### CLASSIC 260 × 234

with gutter, 32 jets

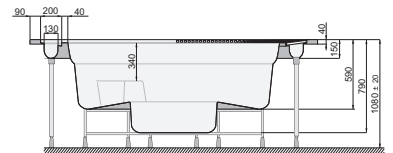
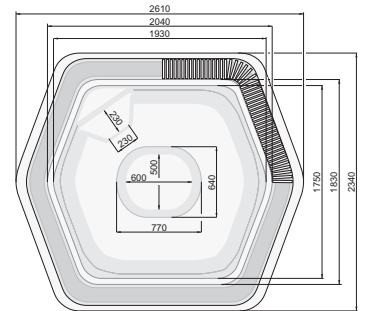

### GENERAL INFORMATION

length:	260 cm	number of jets:	32
width:	234 cm	number of air holes:	106
height:	108 ± 2 cm	number of suctions:	4
number of seats:	5	number of hidden air inlets:	4
capacity:	1400 l	number of massage points:	138

Jets layout A

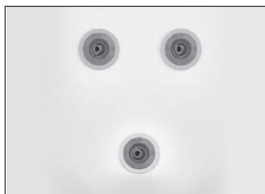

Jets layout C

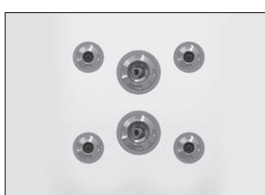

Jets layout D

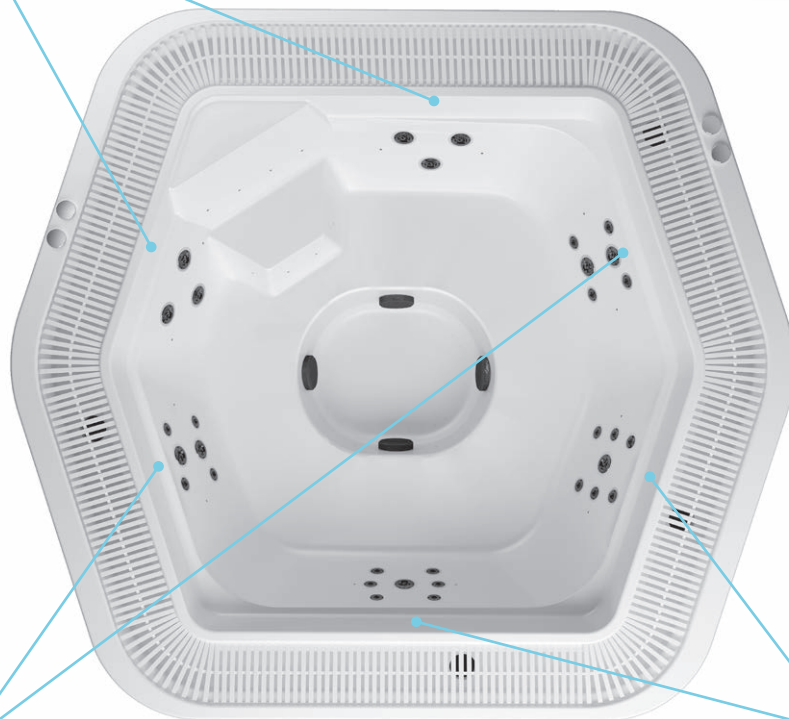
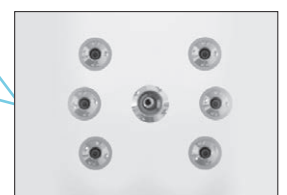

# STATIONARY SPA BATHTUBS

MULTI-USER, PREPLUMBED VERSIONS

# POOLSPA

## NATALIE 253 × 253

with gutter

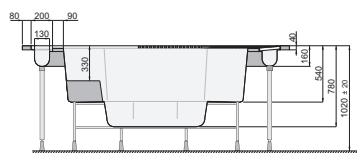
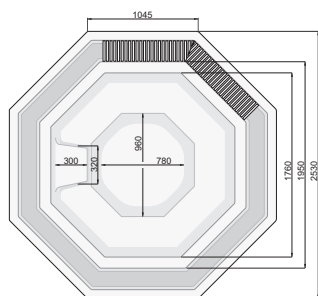

	PRODUCT / EQUIPMENT	CATALOGUE NO.	NET PRICE EUR
7 jets	SPA preplumbed with air channels	PWW8910U00B0000	11 300
	SPA preplumbed with air channels + white LED light	PWW8910U00B0209	11 830
	SPA preplumbed with air channels + 24 multicolor LED lights	PWW8910U00B1885	13 040
14 jets	SPA preplumbed with air channels	PWW8910U02B0000	12 800
	SPA preplumbed with air channels + white LED light	PWW8910U02B0209	13 330
	SPA preplumbed with air channels + 24 multicolor LED lights	PWW8910U02B1885	14 540
	Full foaming		690
	Brown thermal cover	PI9000321	3 030

### GENERAL INFORMATION

length:	253 cm	number of jets:	7-14
width:	253 cm	number of air holes:	111
height:	102 ± 2 cm	number of suction:	3-4
number of seats:	5	number of hidden air inlets:	2-4
capacity:	1300 l	number of massage points:	118-125

	PRODUCT / EQUIPMENT	CATALOGUE NO.	NET PRICE EUR
32 jets	SPA preplumbed with air channels + white LED light	PWW8910U32B0209	15 500
	SPA preplumbed with air channels + 24 multicolor LED lights	PWW8910U32B1885	16 710
	Full foaming		690
	Brown thermal cover	PI9000321	3 030

### NATALIE 253 × 253

with gutter, 32 jets

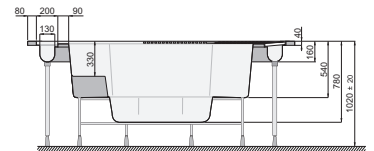
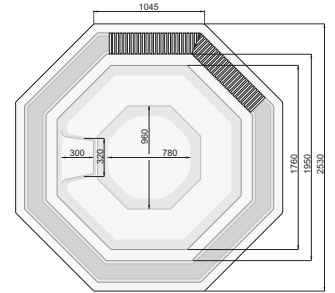

GENERAL INFORMATION			
length:	253 cm	number of jets:	32
width:	253 cm	number of air holes:	111
height:	102 ± 2 cm	number of suctions:	4
number of seats:	5	number of hidden air inlets:	4
capacity:	1300 l	number of massage points:	143

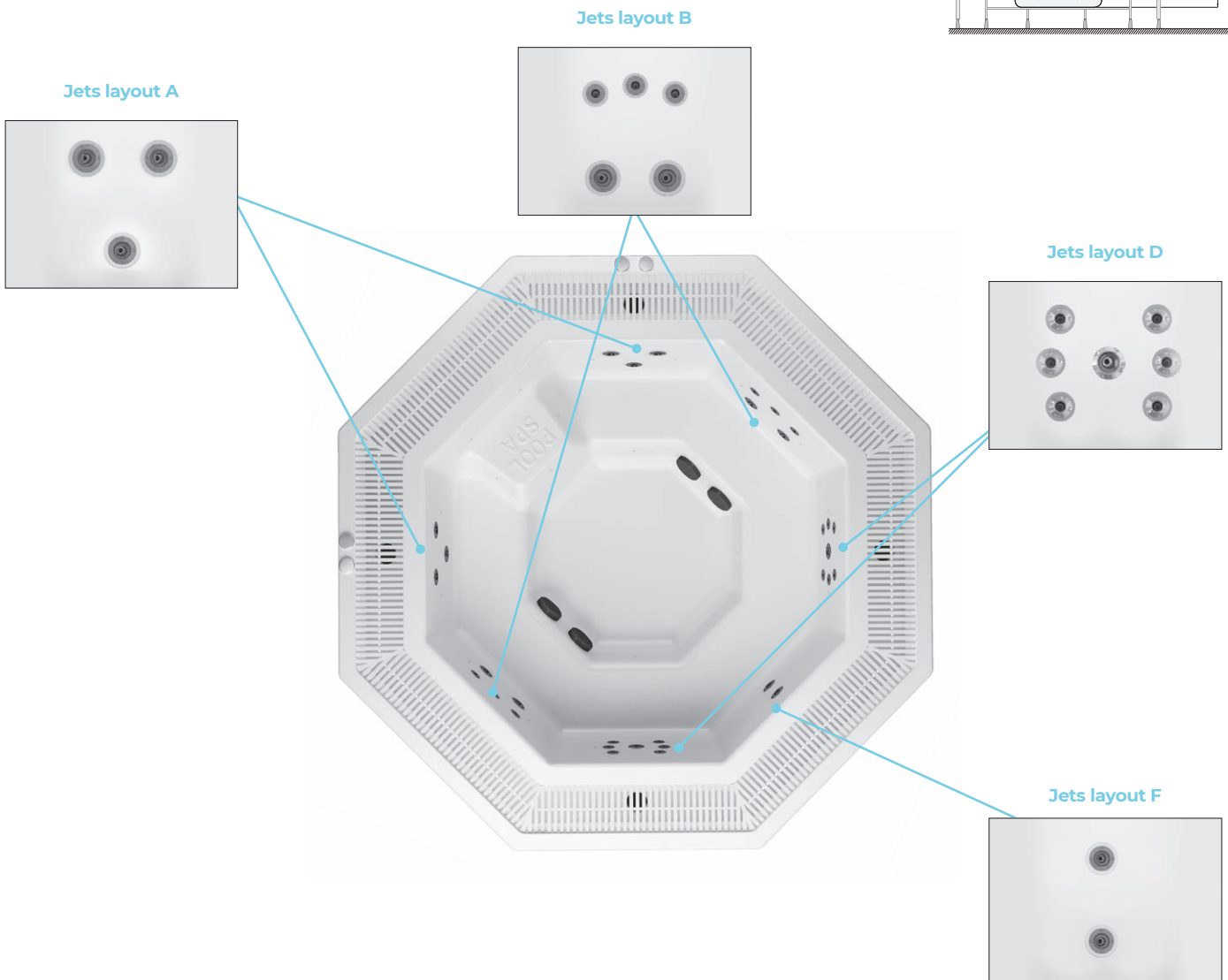

# STATIONARY SPA BATHTUBS

MULTI-USER, PREPLUMBED VERSIONS

# POOLSPA

## SUNFLOWER Ø 283

with gutter

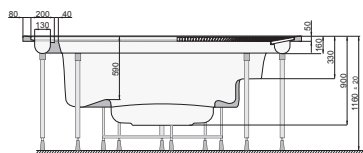
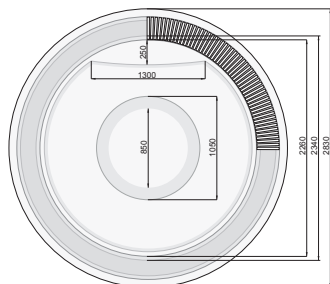

	PRODUCT / EQUIPMENT	CATALOGUE NO.	NET PRICE EUR
14 jets	SPA preplumbed with air channels	PWW8M10U00B0000	14 900
	SPA preplumbed with air channels + white LED light	PWW8M10U00B0209	15 430
	SPA preplumbed with air channels + 24 multicolor LED lights	PWW8M10U00B1885	16 640
	Full foaming		690
	Brown thermal cover	PI9000322	3 150

### GENERAL INFORMATION

length:	283 cm	number of jets:	14
width:	283 cm	number of air holes:	142
height:	116 ± 2 cm	number of suction:	4
number of seats:	8	number of hidden air inlets:	4
capacity:	2000 l	number of massage points:	156

	PRODUCT / EQUIPMENT	CATALOGUE NO.	NET PRICE EUR
<b>32 jets</b>	SPA preplumbed with air channels + white LED light	PWW8M10U32B0209	16 800
	SPA preplumbed with air channels + 24 multicolor LED lights	PWW8M10U32B1885	18 010
	Full foaming		690
	Brown thermal cover	PI9000322	3 150

### SUNFLOWER Ø 283

with gutter, 32 jets

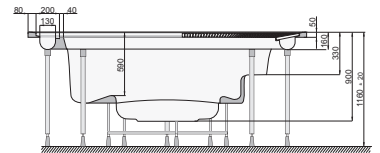
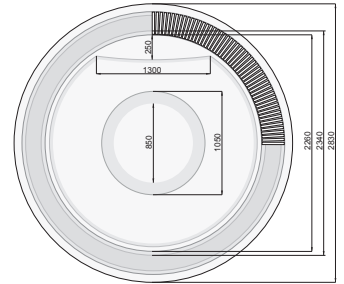

### GENERAL INFORMATION

length:	283 cm	number of jets:	32
width:	283 cm	number of air holes:	142
height:	116 ± 2 cm	number of suctions:	4
number of seats:	8	number of hidden air inlets:	4
capacity:	2000 l	number of massage points:	174

Jets layout F



Jets layout A



Jets layout B



Jets layout C

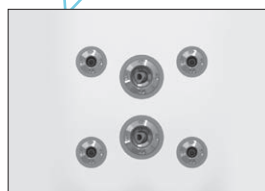

# STATIONARY SPA BATHTUBS

MULTI-USER, PREPLUMBED VERSIONS

# POOLSPA

## VESTA 230 × 230

with skimmer

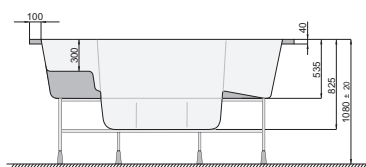
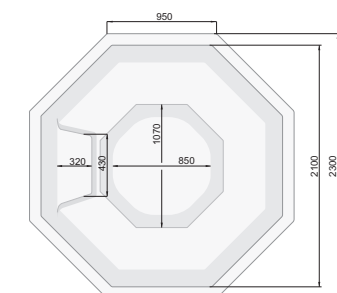

	PRODUCT / EQUIPMENT	CATALOGUE NO.	NET PRICE EUR
7 jets	SPA preplumbed with air channels	PWW8C10U00B0000	8 900
	SPA preplumbed with air channels + white LED light	PWW8C10U00B0209	9 430
	SPA preplumbed with air channels + 24 multicolor LED lights	PWW8C10U00B1885	10 640
14 jets	SPA preplumbed with air channels	PWW8C10U02B0000	10 500
	SPA preplumbed with air channels + white LED light	PWW8C10U02B0209	11 030
	SPA preplumbed with air channels + 24 multicolor LED lights	PWW8C10U02B1885	12 240
	Full foaming		690
	Brown thermal cover	PI9000324	2 550

### GENERAL INFORMATION

length:	230 cm	number of jets:	7-14
width:	230 cm	number of air holes:	140
height:	108 ± 2 cm	number of suction:	2-3
number of seats:	7	number of air regulators:	2-4
capacity:	1100 l	number of massage points:	147-154

## VESTA 290 × 290

with gutter

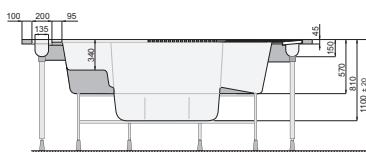
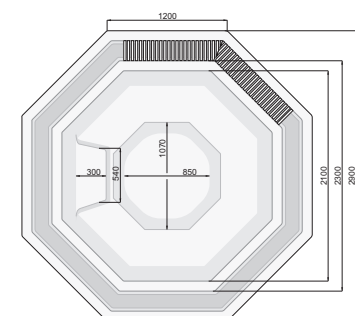

	PRODUCT / EQUIPMENT	CATALOGUE NO.	NET PRICE EUR
7 jets	SPA preplumbed with air channels	PWW8B10U00B0000	12 400
	SPA preplumbed with air channels + white LED light	PWW8B10U00B0209	12 930
	SPA preplumbed with air channels + 24 multicolor LED lights	PWW8B10U00B1885	14 140
14 jets	SPA preplumbed with air channels	PWW8B10U02B0000	13 900
	SPA preplumbed with air channels + white LED light	PWW8B10U02B0209	14 430
	SPA preplumbed with air channels + 24 multicolor LED lights	PWW8B10U02B1885	15 640
	Full foaming		690
	Brown thermal cover	PI9000323	3 150

### GENERAL INFORMATION

length:	290 cm	number of jets:	7-14
width:	290 cm	number of air holes:	140
height:	110 ± 2 cm	number of suction:	3-4
number of seats:	7	number of hidden air inlets:	2-4
capacity:	1600 l	number of massage points:	147-154



# STATIONARY SPA BATHTUBS

MULTI-USER, PREPLUMBED VERSIONS

# POOLSPA

## OLIVIA 248 × 299

with gutter

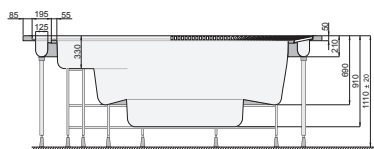
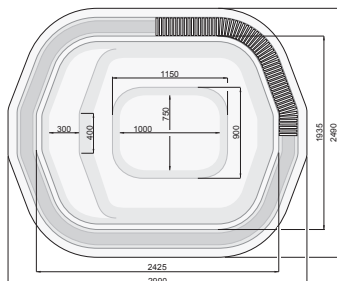

	PRODUCT / EQUIPMENT	CATALOGUE NO.	NET PRICE EUR
13 jets	SPA preplumbed with air channels	PWW8810U00B0000	13 500
	SPA preplumbed with air channels + white LED light	PWW8810U00B0209	14 030
	SPA preplumbed with air channels + 24 multicolor LED lights	PWW8810U00B1885	15 240
	Full foaming		690
	Brown thermal cover	PI9000325	3 150

### GENERAL INFORMATION

length:	248 cm	number of jets:	13
width:	299 cm	number of air holes:	161
height:	111 ± 2 cm	number of suctions:	4
number of seats:	7	number of hidden air inlets:	4
capacity:	2100 l	number of massage points:	174

	PRODUCT / EQUIPMENT	CATALOGUE NO.	NET PRICE EUR
<b>32 jets</b>	SPA preplumbed with air channels + white LED light	PWW8810U32B0209	15 700
	SPA preplumbed with air channels + 24 multicolor LED lights	PWW8810U32B1885	16 910
	Full foaming		690
	Brown thermal cover	PI9000325	3 150

### OLIVIA 248 × 299

with gutter, 32 jets

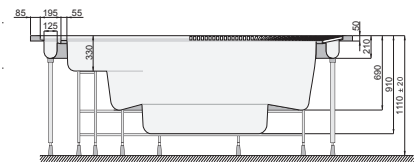
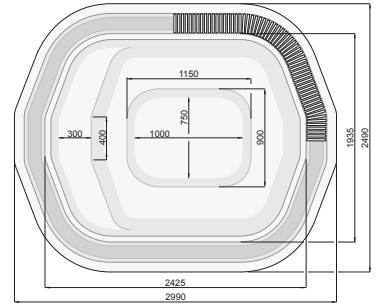

#### GENERAL INFORMATION

length:	248 cm	number of jets:	32
width:	299 cm	number of air holes:	161
height:	111 ± 2 cm	number of suctions:	4
number of seats:	7	number of hidden air inlets:	4
capacity:	2100 l	number of massage points:	193

Jets layout A

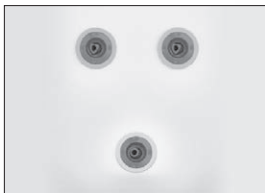

Jets layout B



Jets layout F



Jets layout D

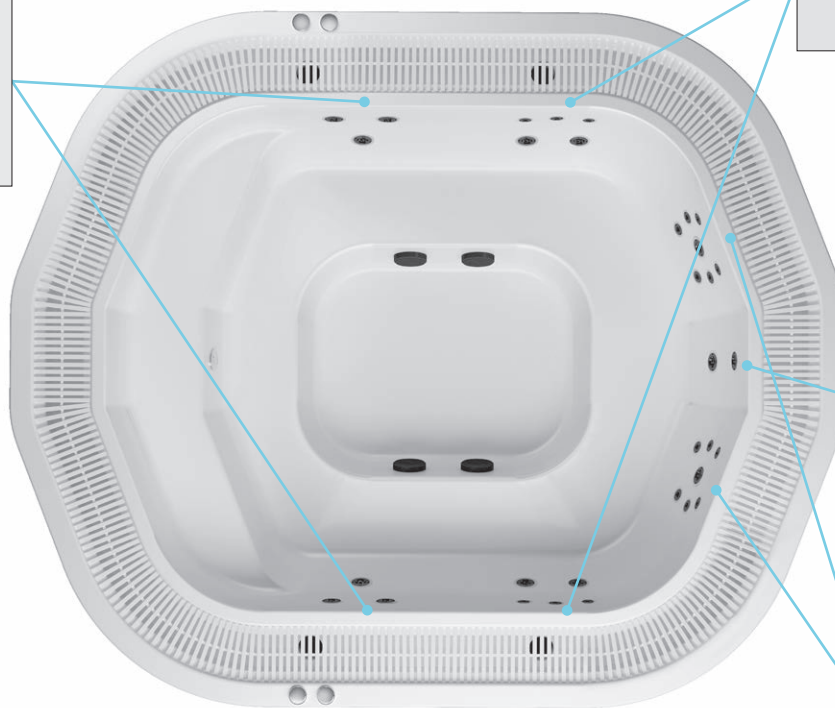

from pump supply for hydromassage Ø63

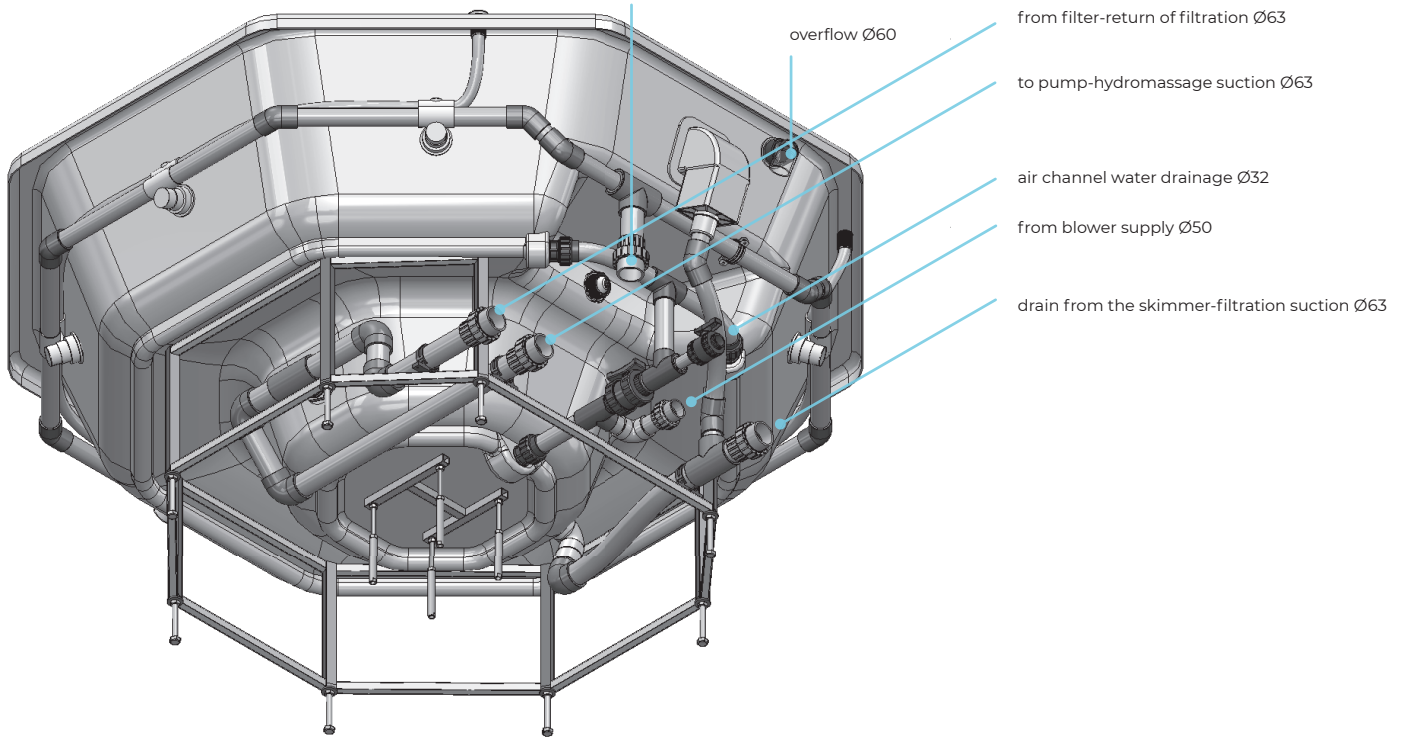

Plumbing scheme for a SPA bathtub with a skimmer and a single number of jets, as found in the Vesta bathtub.

overflow Ø60

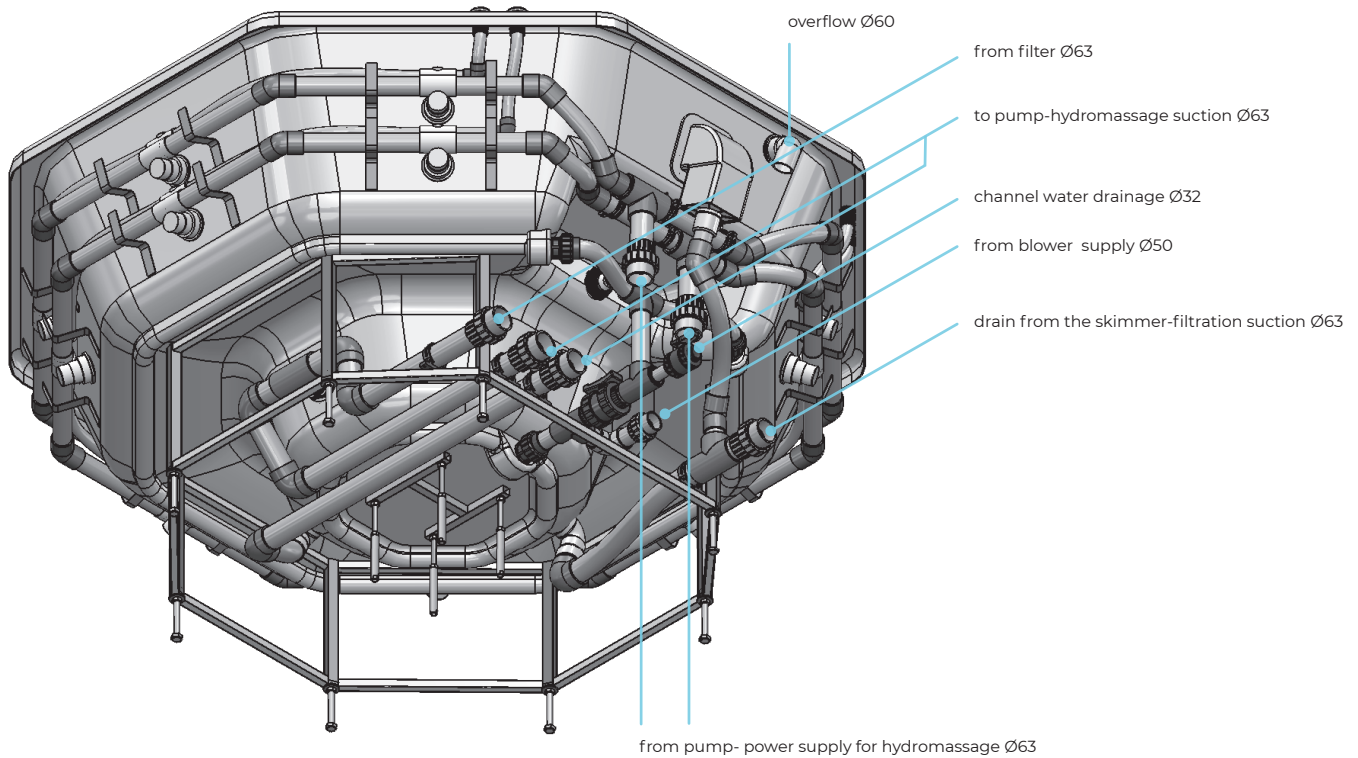

Plumbing scheme for a SPA bathtub with a skimmer and a double number of jets, as found in the Vesta bathtub.

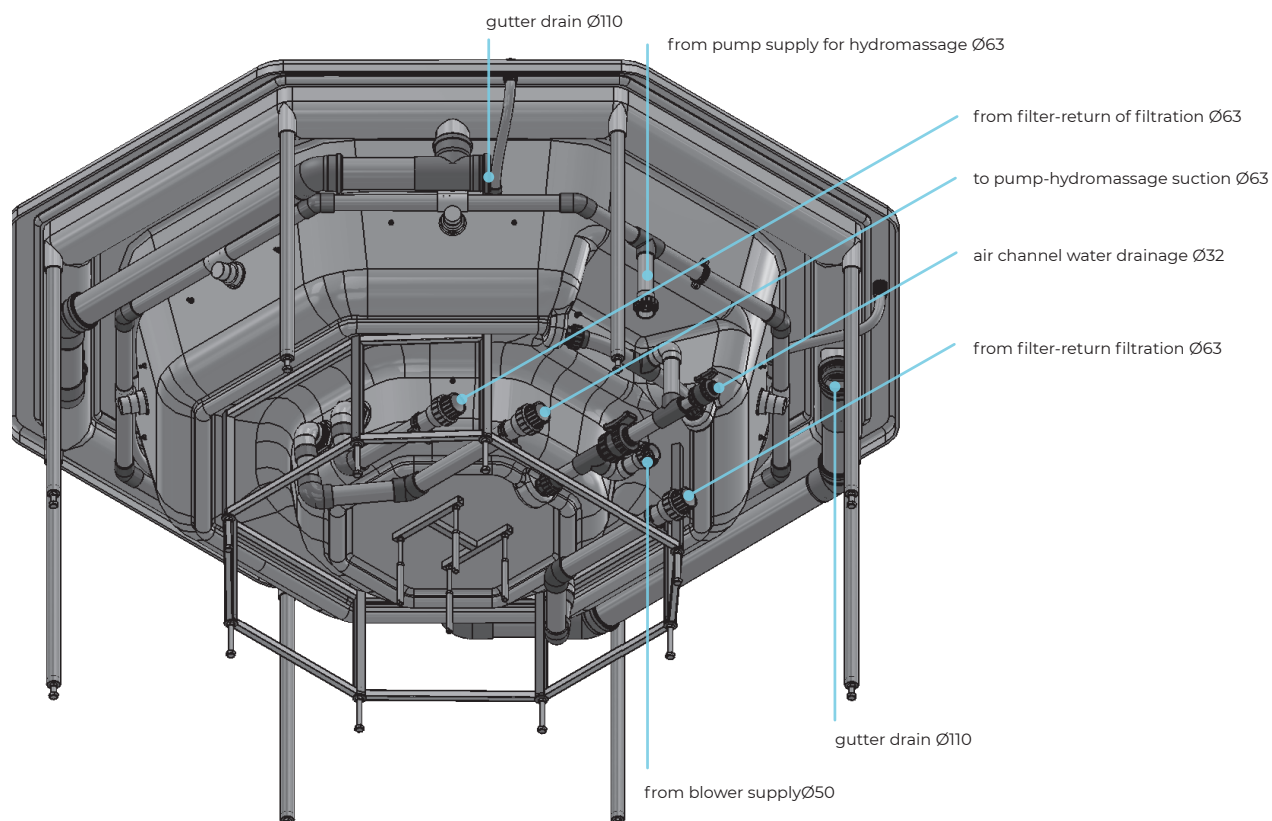

Plumbing scheme for a SPA bathtub with a gutter and a single number of jets, as found in the Vesta bathtub.

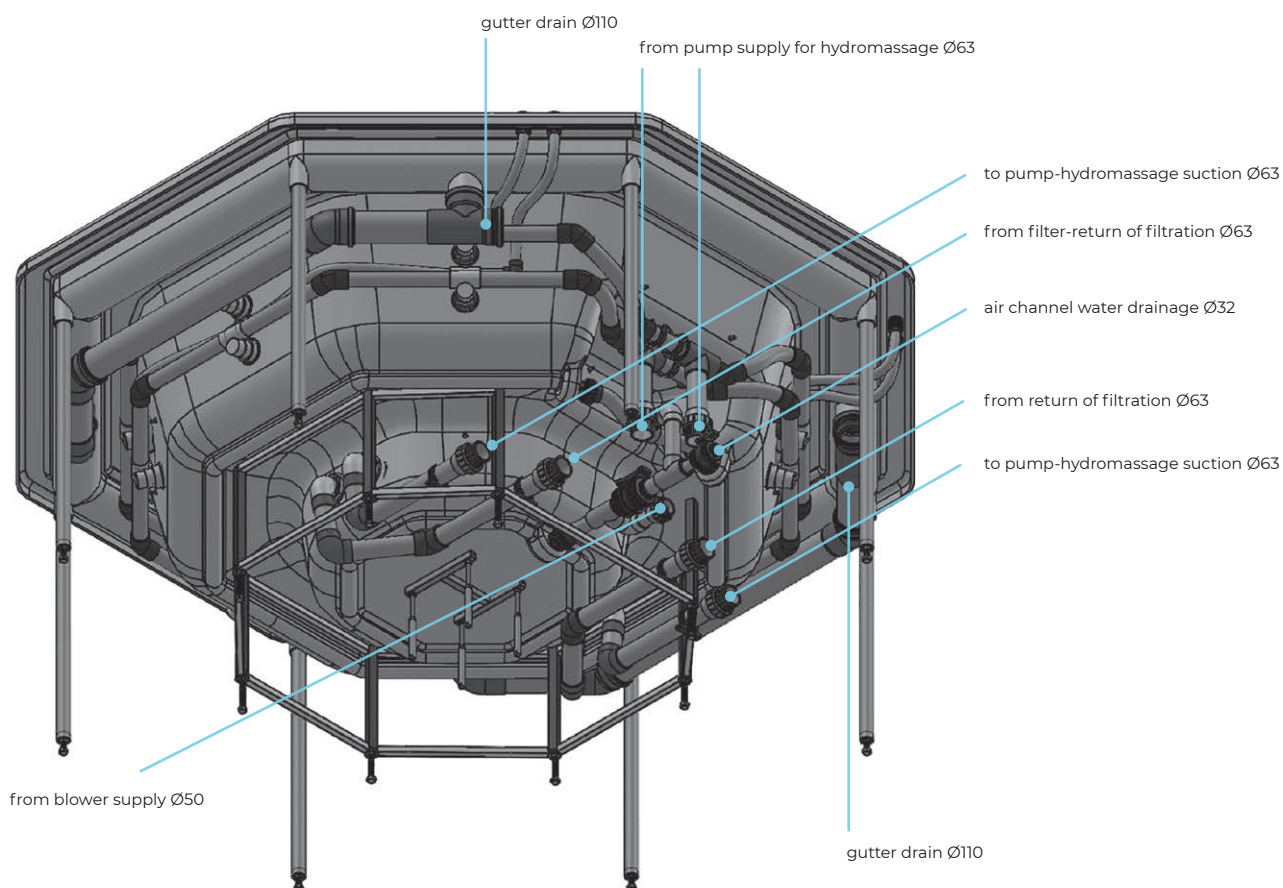

Plumbing scheme for a SPA bathtub with a gutter and a double number of jets, as found in the Vesta bathtub.

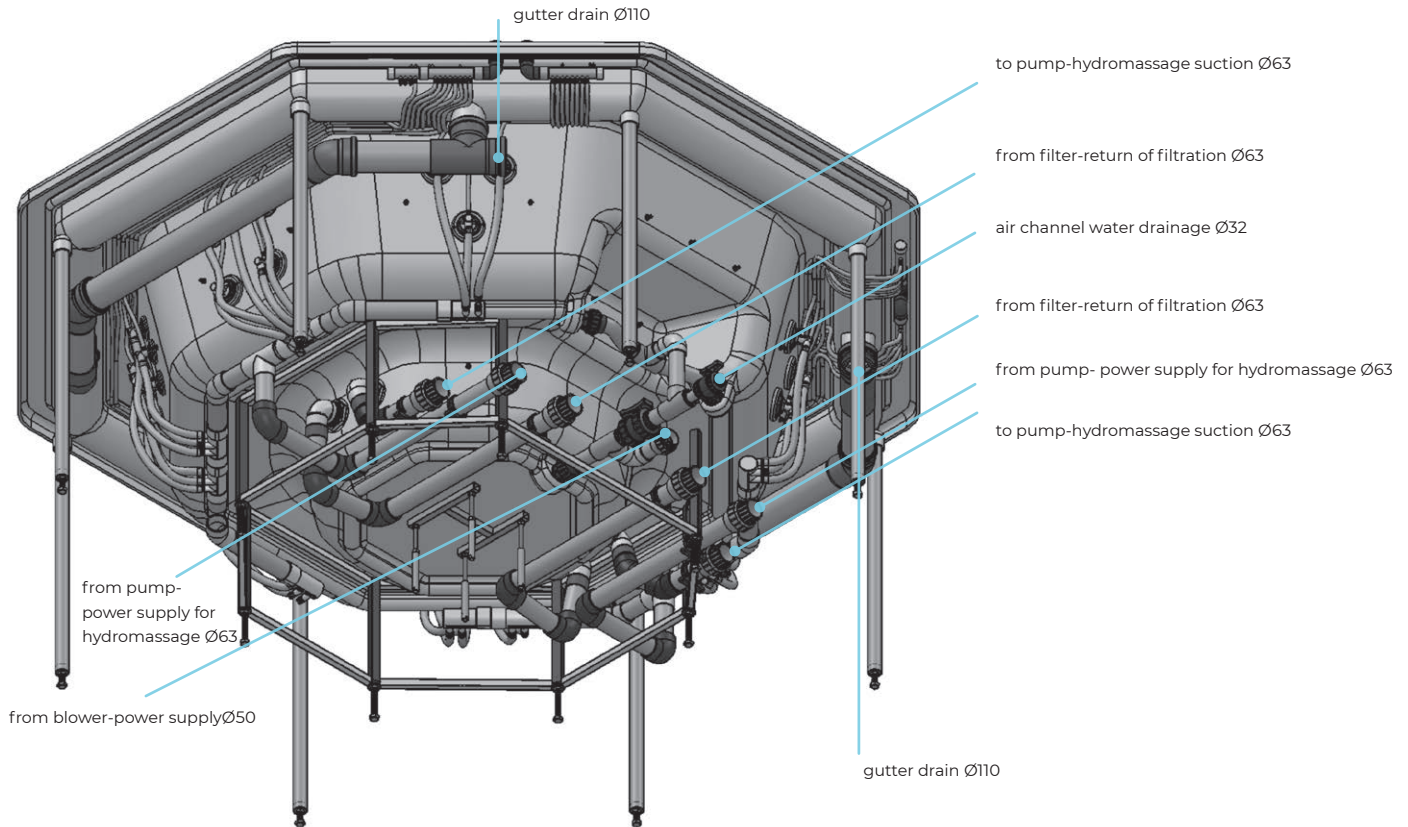

Plumbing scheme for a SPA bathtub with a gutter and 32 jets, as found in the Vesta bathtub.

### Jets in standard SPA bathtubs:



Jet SPA Magna - stainless steel

### Jets in SPA bathtubs with 32 Jets:



Rotating Jet A 2.5 slim



Fixed Jet A 3.5 slim



Rotating Jet A 3.5 slim

1. The warranty provisions below apply to all products manufactured by Roca Pool-Spa Sp. z o.o., further referred to in these Warranty Terms and Conditions as the "Seller".
2. The Seller warrants that the products were constructed and manufactured without defects and will operate faultlessly if used as the manufacturer's instructions.
3. The warranty shall cover all manufacturing defects or failures during the warranty period that are attributable to the manufacturer, and shall result in free repair or replacement of parts, and if it is not possible – replacement of the entire device.
4. The Seller shall provide warranty to the Buyer for the following categories of products:

PRODUCT CATEGORY	PRODUCT SURFACE	OTHER ELEMENTS
SPA products	5 years	2 years

5. The warranty period shall start on the date of product purchase indicated on the proof of purchase.
6. The external surface of the product should be inspected by the Buyer at the place of purchase (also if the product is in the original packaging). Any later complaints about external damage filed following product collection or assembly shall not be allowed.
7. Before you start assembling the product, you must inspect it for completeness and any visible damage. The Seller shall not be liable for damages caused as a result of installation of the product with a visible defect.
8. Any product defects and damages that you notice must be reported to the Point of Purchase within 7 days from their occurrence, otherwise the warranty shall be void. If it is not possible to contact the Point of Purchase, you must notify the Seller's Service Department in writing, within the deadline indicated above.
9. Any damages to the product identified during the warranty period and not attributable to the Buyer shall be removed for free within 21 calendar days from the receipt of the damage report from the Buyer unless removal of the defect requires spare parts that may have a delivery time longer than 21 days for reasons not attributable to the Seller.
10. The Seller shall reserve its right to decide during defect removal whether parts of the product should be repaired or replaced with new parts. Defective (replaced) parts shall become the property of the Seller.
11. The product should be installed in a manner that enables convenient service access. Convenient service access must enable removal (for repair or replacement) of the product without generating additional costs (of material or labour) related to the product or other interior or building components into which the product was permanently embedded. The Seller shall not cover the costs (of materials or labour) associated to the removal of the claimed product.
12. Costs of unjustified complaint, in particular the costs of transport and labour shall be calculated on the basis of the Seller's price list applicable for maintenance service, inspections, examinations and expert opinions and shall be covered by the Buyer.
13. Warranty repairs shall not include activities performed normally during product use such as regular maintenance, decalcification, cleaning, which must be performed by the user at their own expense.
14. After the expiry of the warranty period, the Seller shall provide payable post-warranty service.
15. This warranty shall not exclude, limit or withhold the Buyer's rights arising from non-conformity of the product with the agreement.
16. For SPA products, for the warranty to be valid, the tubs must be installed by an installer with electric qualification certificate.
17. The warranty shall not apply to products sold at a discount.
18. The Buyer's warranty shall be voided if:
  - non-original parts are used,
  - the product is not used as intended
  - additional devices are mounted on the product
  - in the case of damage caused when making holes for faucets
  - in the case of mechanical damage, e.g. strike, chipping, scratching (including fittings)
  - damage caused by water impurity, scale deposits or lack of filters for mechanical impurities
  - non-compliance with the rules for operation, handling and maintenance included in product manuals
  - repairs or conversions performed by persons who were not authorised to do so by the Seller.
19. The Seller shall not be liable for any damages to individuals or assets that may be caused by any of the reasons referred to in item 18.

For warranty claims, please contact:

**Roca Pool-Spa Sp. z o.o.**  
 ul. Dąbskiego 35, 72-300 Gryfice  
 phone: +48 91 38 777 00  
 www.poolspace.pl, e-mail: poolspace@pl.roca.com

The Manufacturer reserves the right to modify the appearance, design or parameters of the products shown in this product catalogue without advance notice. The interior design of areas shown in this catalogue may not necessarily meet requirements for a properly designed plumbing system. Actual product colours may vary from colours shown in the catalogue. This brochure does not constitute an offer within the meaning of applicable regulations.

This price list does not constitute an offer within the meaning of applicable regulations. The manufacturer reserves the right to make adjustments to both products and prices. Furthermore, the Manufacturer assumes no liability for printing errors. Prices in individual stores may vary from the above recommended prices, depending on the type and level of pre- and after-sales service provided by the Seller.







## The brand you can trust!

### DEVELOPMENT FOR CUSTOMERS BENEFIT

As the forerunner of the wellness idea, POOLSPA is the market leader among the manufacturers of luxury hydro-massage devices. It owes this top position to many years of experience as well as constant search for innovative solutions that would provide its Customers with better health, beauty and physical and mental state.

### POLISH MANUFACTURER - GLOBAL POWER

POOLSPA products are made in Poland where the company located one of the most modern plants in this business. Therefore the customers can be serviced promptly and they can rely on the delivery of the ordered goods and their parts on time as well as on reasonable prices and the European quality level.

### INNOVATIVE TECHNOLOGIES

Offered under the POOLSPA brand, modern products, made in composite and conglomerate technology open up new possibilities for the interior design of bathrooms and bathing rooms. The combination of all the features of modern design and unique material created for bathroom spaces is ideal for everyday use.

### TOP QUALITY ACRYLIC

POOLSPA products are the choice for years. The application of top quality sanitary acrylic makes the products long lasting and all models perfect finishing together with the thorough material quality control during the technological process help to ensure a long guarantee time for each item. Touching any POOLSPA bath feels smooth, warm and pleasant and its colour is intense and durable.

### COMPONENTS FROM REPUTED SUPPLIERS

All the devices bearing POOLSPA logo combine a sophisticated design with the highest functional values. They are all made with a special care even about the tiniest detail with regard to both, their aesthetic look and their reliability. There is no place left for any quality compromise - the company's suppliers are the leading world-wide bath components manufacturers.

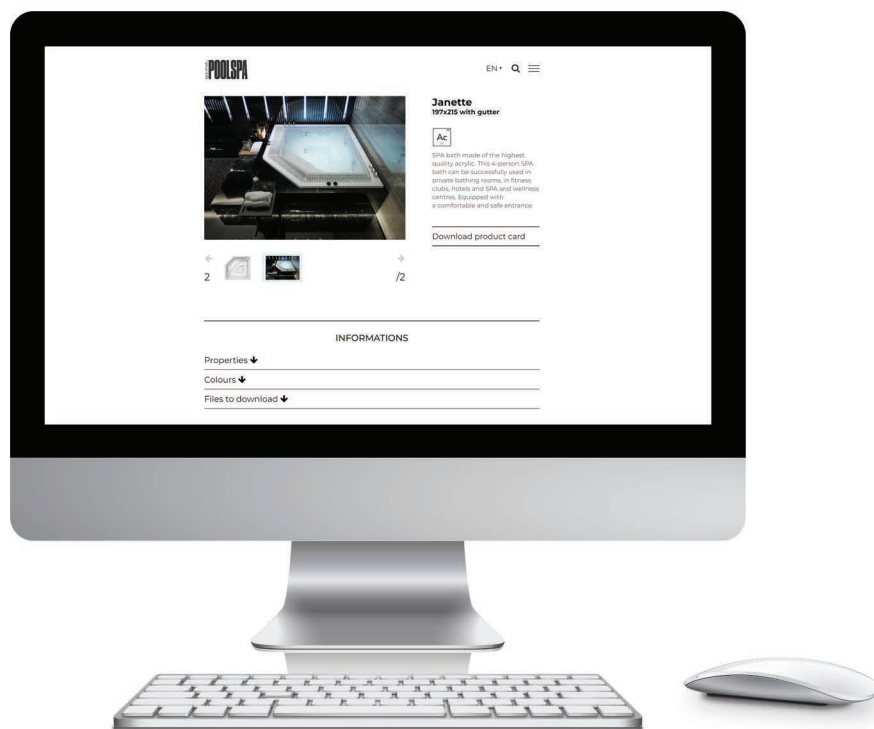

# POOLSPA

**Roca Pool-Spa Sp. z o.o.**  
ul. Wyczółkowskiego 20  
44-109 Gliwice

[www.poolspa.pl](http://www.poolspa.pl)

**Production Plant**  
ul. Jana Dąbskiego 35  
72-300 Gryfice

phone: +48 91 38 777 00  
fax: +48 91 38 777 01  
[poolspa@pl.roca.com](mailto:poolspa@pl.roca.com)

